

YOUR
OWN
STYLE
ACCESSORIES

 **inda**[®]
bathroom interiors

INDEX

Your own style.

HISTORY	2	GRAB-BARS	142
TOTAL LIVING	4	STOOLS	146
MY LOVE	6	BASKET	148
MY WAY	14	STANDS	154
MY LIKE	16	TABLETOP SERIES	158
MY MIRROR	18	MIRRORS AND LAMPS	162
MY SECRET	24	FINISHES	170
INDISSIMA	34	SYMBOL KEY	175
INDISSIMA CHROME	48		
GEALUNA	52		
MITO	62		
DIVO	68		
LEA	74		
ONE	84		
LOGIC	92		
TOUCH	98		
EGO	106		
AVENUE	112		
RAFFAELLA	118		
FORUM QUADRA	124		
FORUM	130		
COMFORT	136		

HISTORY

A new way for conceiving the bathroom.

Inda, Gruppo Industriale italiano del settore arredobagno, con i suoi 70 anni d'esperienza è, dal 1944, al servizio di chi desidera arredare il proprio ambiente bagno con stile e funzionalità. La capacità del Gruppo di cogliere le esigenze ed i gusti di un pubblico eterogeneo in continuo cambiamento e di anticipare le tendenze dell'abitare, gli ha permesso di consolidare la leadership nei mercati internazionali. Sono tre le divisioni di prodotto del Gruppo: mobili, pareti doccia ed accessori, le cui creazioni formano in realtà un pensiero unico, ideale per infinite soluzioni d'arredamento della sala da bagno. Creatività, originalità, distintiva eleganza sono elementi caratterizzanti che si esprimono nel design Inda attraverso tutte le sue forme, dal classico, al moderno alle soluzioni più all'avanguardia, che rispondono armoniosamente

all'evoluzione dell'abitare. Un progetto globale che si declina in ogni situazione architettonica, grazie all'eccezionale versatilità e dedizione delle proprie risorse creative e produttive.

Since 1944, with over 70 years of experience, Inda - Italian producer of bathroom furniture, accessories and shower enclosures - has been helping its customer to stylish and ergonomically furnish their bathrooms. The Group's ability to capture the needs and tastes of a diverse, constantly-changing public and anticipate current trends has helped it consolidate its leading place in international markets. The Group has three product ranges: furniture, shower enclosures and accessories. Its creations shape a unifying design, ideal for endless bathroom-furnishing solutions.

Inda's design arises from creativity, originality and distinctive elegance expressing on all styles from classic to modern, to the most avant-garde solutions, that respond harmoniously to the way living evolves. It is a global project that comes through in every architectural situation thanks to the exceptional versatility and dedication of its creative and productive resources.





TOTAL LIVING

A bathroom with a coordinated aesthetics.

Il bagno, oggi più che mai, è diventato uno spazio imprescindibile del nostro ambiente domestico, passando da un luogo di servizio a una vera e propria esperienza totalizzante. Per questo motivo, Inda propone diverse soluzioni di abbinamento estetico riguardante diverse categorie di prodotto, per arredare il tuo bagno con un'estetica coordinata. Pareti doccia, mobili, accessori: tutto è perfettamente abbinato.

Today more than ever, bathrooms have become an essential space in our home environment, going from being somewhere to freshen up to a real all-encompassing experience. This is why Inda offers different matching aesthetic solutions for different product categories to furnish your bathroom with a coordinated look. Shower enclosures, furniture, accessories: everything fits perfectly together.





MY LOVE / MY WAY / MY LIKE

New hygenical innovation.

Il design universale si adatta ad ogni contesto!

Corpo esterno, manico e coperchio in ottone cromato, base in plastica polipropilene per non danneggiare le superfici, imbuto di autocentraggio in plastica ABS con trattamento antibatterico. Fondello estraibile e scovolo di ricambio compreso in ogni confezione singola.

The universal design is suitable to any ambience!

Outer part, handle and cover in chrome plated brass, basement in polypropylene plastic to avoid the surfaces' damaging, conical self-centering cover in ABS plastic with antibacterial treatment.

Removable inner part and spare part brush inside every single pack.





MY LOVE / MY WAY / MY LIKE_7

MY LOVE / MY WAY

New hygenical innovation

TRATTAMENTO ANTIBATTERICO
100% di igiene grazie al nuovo
trattamento antibatterico delle
parti in polipropilene. La sostanza
igienizzante viene inserita
direttamente nella materia prima
garantendo l'eterna durata del
trattamento.

ANTIBACTERIAL TREATMENT
100% hygenical thanks to the new
antibacterial treatments of the
polypropylene parts. The substance
is placed directly into the basic
material ensuring the eternal
duration of treatment.

**FUNZIONALITÀ
FUNCTIONALITY**



Innovativo sistema autocentrante: la forma conica del coperchio facilita l'inserimento dello scovolo e assicura la corretta chiusura dello scovino

Innovative self-centering-system: the conical shape of the cover simplify the insertion of the brush and ensures proper closing of the toilet brush

**VERSATILITÀ
VERSATILITY**

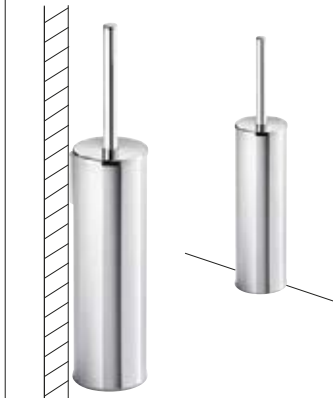

Lo stesso prodotto può essere utilizzato in appoggio o installato a parete poiché la placca per il fissaggio è sempre compresa nella confezione

The same product is suitable as free-standing or wall mounted because the wall mounting plate is always included in the package

**RICARICABILE
RECHARGEABLE**



Sostituisci lo scovolo senza toccare le parti non igieniche: impugnare il coperchio e ruota il manico. La parte intercambiabile si sgancia automaticamente consentendone la sostituzione

Replace the brush without touching any unsanitary part: holding the cover and turning the handle. The interchangeable part will be released automatically allowing the substitution



MY LOVE

Ogni confezione singola è dotata di uno scovolo di ricambio
Every single packet has a spare part brush



Manico e coperchio in ottone cromato
Handle and cover in chrome plated brass

Imbuto di autocentraggio in plastica ABS con trattamento antibatterico
Conical self-centering cover in ABS plastic with antibacterial treatment

Fondello estraibile in plastica polipropilene con trattamento antibatterico; trattiene l'acqua di scolo dello scovolo e ne facilita la pulizia
Removable inner part in polypropylene plastic with antibacterial treatment; collect water from the brush and simplify the cleaning

Corpo esterno in ottone cromato; il design universale si adatta ad ogni contesto
Outer part in chrome plated brass; the universal design is suitable to any ambience

Base in plastica polipropilene; evita il danneggiamento delle superfici e garantisce una maggiore silenziosità durante l'appoggio
Basement in polypropylene plastic; avoid the damaging of surface areas and guarantees a quiet set down



AV014A CR

Portascopino da parete/da appoggio.
Scovolo di ricambio bianco incluso
Wall mounted/free-standing toilet brush
holder. White spare brush included
9 x 40H x 9 cm

**AV014A AS****AV014A GE****AV014A CS****AV014A OS****AV014A OR****AV014A DR****AV014A BZ****AV014A WZ****AV014A WM****AV014A WY**

AV014B CR

Portascopino da parete/da appoggio.
Scovolo di ricambio nero incluso
Wall mounted/free-standing toilet brush
holder. Black spare brush included
9 x 40H x 9 cm

**AV014B CG****AV014B CF****AV014B NE****AV014B NC****AV014B AC****AV014B CO****AV014B RM****AV014B ML**



MY WAY

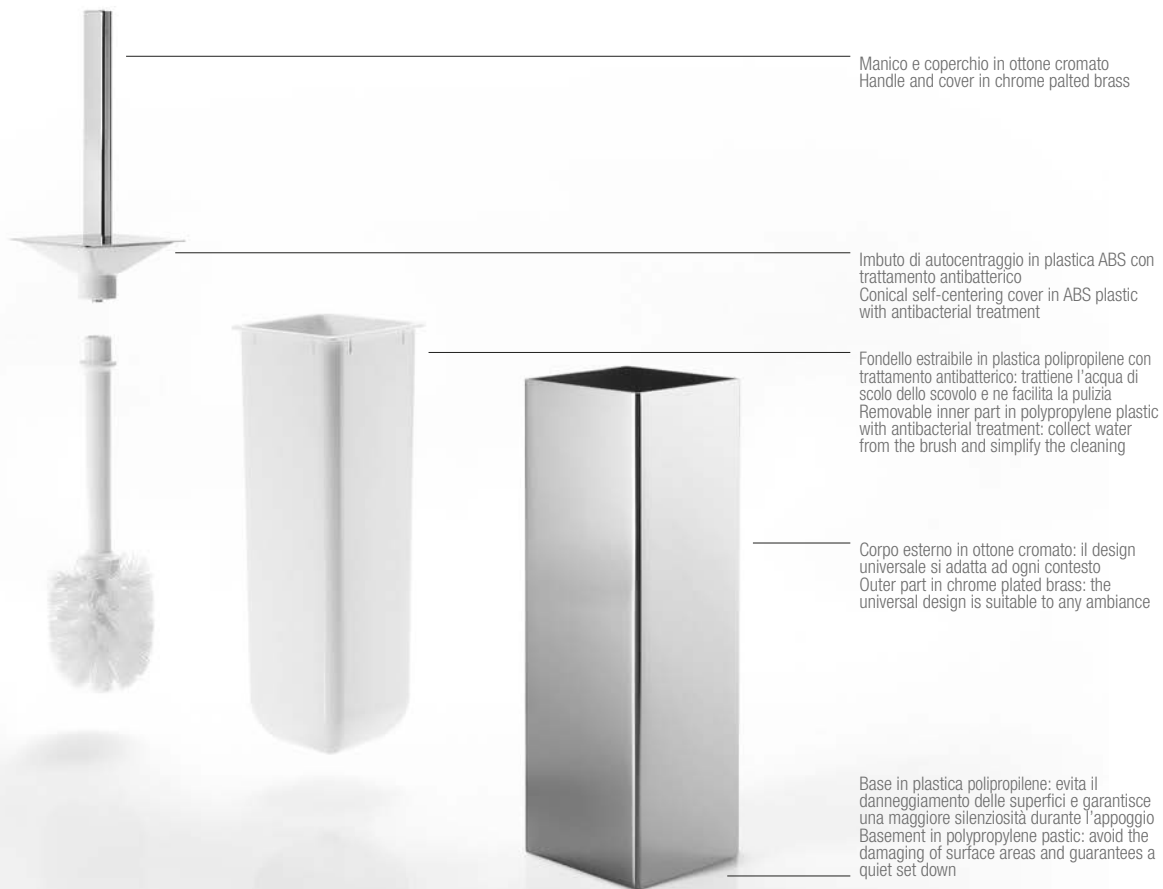

Manico e coperchio in ottone cromato
Handle and cover in chrome patted brass

Imbuto di autocentraggio in plastica ABS con
trattamento antibatterico
Conical self-centering cover in ABS plastic
with antibacterial treatment

Fondello estraibile in plastica polipropilene con
trattamento antibatterico; trattiene l'acqua di
scolo dello scovolo e ne facilita la pulizia
Removable inner part in polypropylene plastic
with antibacterial treatment; collect water
from the brush and simplify the cleaning

Corpo esterno in ottone cromato; il design
universale si adatta ad ogni contesto
Outer part in chrome plated brass; the
universal design is suitable to any ambience

Base in plastica polipropilene; evita il
danneggiamento delle superfici e garantisce
una maggiore silenziosità durante l'appoggio
Basement in polypropylene pastic; avoid the
damaging of surface areas and guarantees a
quiet set down

AV114A CR

Portascopino da parete/da appoggio
Wall mounted/free-standing toilet brush
holder
9 x 40H x 9 cm

**AV114A AC****AV114A WM****AV114B NE**

Portascopino da parete/da appoggio
Wall mounted/free-standing toilet brush
holder
9 x 40H x 9 cm





MY LIKE



Imbuto di autocentraggio in plastica ABS
Conical self-centering cover in ABS plastic



Il design universale si adatta ad ogni contesto
The universal design is suitable to any
ambiance



Base in plastica polipropilene; evita il
danneggiamento delle superfici e garantisce
una maggiore silenziosità durante l'appoggio
Basement in polypropylene pastic; avoid the
damaging of surface areas and guarantees a
quiet set down

AV414A AL

Portascopino da parete/da appoggio
Wall mounted/free-standing toilet brush
holder
8 x 38H x 8 cm



AV414A NS



MY MIRROR

A new light has come.

Una nuova serie di specchi ingranditori, sia d'appoggio che da parete, disponibili anche con luce LED integrata. Sono l'accessorio ideale per il make-up e per vedere i dettagli del proprio viso.

A new serie of magnifying mirrors, both supporting and wall mounted, also available with integrated LED lighting. They are the ideal accessory for makeup and to see the details of your face.





AV258A

Specchio ingranditore a parete con braccio snodato. Accensione touch. Dimmerabilità colore luce. Collegamento diretto a rete o con presa di corrente

Wall-mounted magnifying mirror with articulated arm. Touch switch on. Dimmable light color. Direct connection to the mains or with a socket

20 x 24H x 28 cm
100-240V 50-60Hz 2,5W



AV258C

Specchio ingranditore a parete con braccio snodato. Accensione touch. Dimmerabilità colore luce. Collegamento diretto a rete o con presa di corrente

Wall-mounted magnifying mirror with articulated arm. Touch switch on. Dimmable light color. Direct connection to the mains or with a socket

20 x 24H x 27 cm
100-240V 50-60Hz 2,5W



AV258B

Specchio ingranditore a parete con doppio braccio snodato.

Accensione touch. Dimmerabilità colore luce. Collegamento diretto a rete o con presa di corrente

Wall magnifying mirror with double jointed arm. Touch switch on. Dimmable light color. Direct connection to the mains or with a socket

20 x 21H x 43 cm
100-240V 50-60Hz 2,5W



AV258D

Specchio ingranditore a parete con doppio braccio snodato.

Accensione touch. Dimmerabilità colore luce. Collegamento diretto a rete o con presa di corrente

Wall magnifying mirror with double jointed arm. Touch switch on. Dimmable light color. Direct connection to the mains or with a socket

20 x 21H x 43 cm
100-240V 50-60Hz 2,5W



AV258P

Specchio ingranditore da appoggio.

Accensione touch. Dimmerabilità colore luce

Magnifying mirror with support. Touch switch on. Dimmable light color

20 x 43H x 19 cm
100-240V 50-60Hz 2,5W



AV258Q

Specchio ingranditore da appoggio.

Accensione touch. Dimmerabilità colore luce

Magnifying mirror with support. Touch switch on. Dimmable light color

20 x 43H x 18 cm
100-240V 50-60Hz 2,5W



AV058E

Specchio ingranditore a parete con
braccio snodato
Wall-mounted magnifying mirror
with articulated arm
20 x 20H x 27 cm

**AV058F**

Specchio ingranditore a parete con
braccio snodato
Wall-mounted magnifying mirror
with articulated arm
20 x 20H x 27 cm

**AV058L**

Specchio ingranditore a parete con
doppio braccio snodato
Wall magnifying mirror with double
jointed arm
20 x 20H x 42 cm

**AV058M**

Specchio ingranditore a parete con
doppio braccio snodato
Wall magnifying mirror with double
jointed arm
20 x 20H x 40 cm

**AV058P**

Specchio ingranditore da appoggio
Magnifying mirror with support
20 x 41H x 18 cm

**AV058Q**

Specchio ingranditore da appoggio
Magnifying mirror with support
20 x 41H x 17 cm



AV158C

Specchio ingranditore a parete con doppio braccio snodato. Collegamento diretto a rete o con presa di corrente
 Wall magnifying mirror with double jointed arm. Direct connection to the mains or with a socket
 20 x 20H x 43 cm
 100-240V 50-60Hz 6W

**AV058C**

Specchio ingranditore a parete con doppio braccio snodato. Bifacciale. Pivottante
 Wall magnifying mirror with double jointed arm. Double sided. Pivoting
 23 x 32H x 34 cm

**AV058X**

Specchio ingranditore a parete su asta saliscendi
 Wall-mounted magnifying mirror on slide rail bar
 20 x 60H x 16 cm

**AV058Y**

Specchio ingranditore a parete su asta saliscendi
 Wall-mounted magnifying mirror on slide rail bar
 20 x 60H x 15 cm



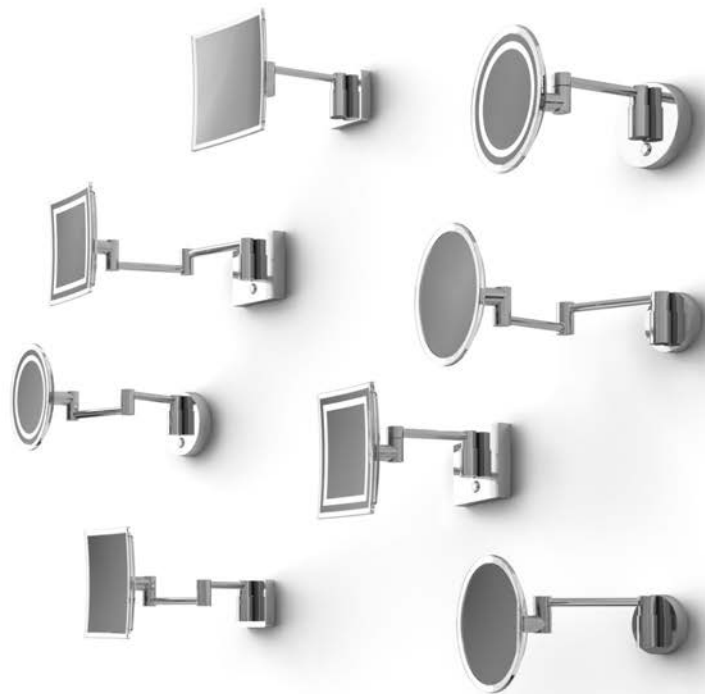

MY SECRET

For an even more exclusive bathroom

My secret: un nuovo concetto di spazio dove l'accessorio da bagno scompare! Un design versatile, un innovativo sistema di incasso a muro - totale o a semincasso o esterno - e una gamma di 10 colori, rendono My secret un componente trasversale che si adatta ad ogni tipo di soluzione, offrendo minimo ingombro e massima funzionalità.

My secret: a new concept of space where the accessory can be tucked away! A versatile design, an innovative wall cabinet system - that can be fully, semi or non-recessed - and a range of 10 colors, make My Secret a transversal element which can fit any bathroom solution, occupying minimum space for maximum practical appeal.





BX
Laccato opaco Bianco
Mat lacquered Bianco



CE
Laccato opaco Cemento
Mat lacquered Cemento



NX
Laccato opaco Nero
Mat lacquered Nero



TL
Laccato opaco Terra di Luna
Mat lacquered Terra di Luna



AQ
Laccato opaco Aquamarina
Mat lacquered Aquamarina

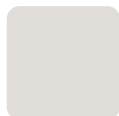

MP
Laccato opaco Perla
Mat lacquered Perla



CX
Laccato opaco Creta
Mat lacquered Creta



AX
Laccato opaco Avorio
Mat lacquered Avorio



BN
Laccato opaco Bruno
Mat lacquered Bruno



GD
Laccato opaco Giada
Mat lacquered Giada









A80750

Modulo da incasso con portabicchiere e spandisapone
 Recessed modul with tumbler holder and soap dispenser
 35 x 26H x 15 cm

**A8085A**

Modulo da incasso con portarotolo e portascopino My Love
 Recessed modul with paper holder and My Love toilet brush holder
 19 x 66H x 15 cm

**A8085B**

Modulo da incasso con portarotolo e idroscopino
 Recessed modul with paper holder and hydrobrush
 19 x 66H x 15 cm

**A8085C**

Modulo da incasso con portarotolo, portarotolo di scorta e My Love
 Recessed modul with paper holder, spare roll holder and My Love
 19 x 86H x 15 cm

**A8085D**

Modulo da incasso con portarotolo, portarotolo di scorta e idroscopino
 Recessed modul with paper holder, spare roll holder and hydrobrush
 19 x 86H x 15 cm

**A8035A**

Modulo da incasso con mensole in vetro, anta battente con specchio interno
 Recessed modul with glass shelves, pivot door with internal mirror
 35 x 160H x 15 cm



A8035B

Modulo da incasso con mensole in vetro, portasciugacapelli, anta battente con specchio interno
 Recessed modul with glass shelves, hairdryer holder, pivot door with internal mirror
 35 x 160H x 15 cm

**A8035C**

Modulo da incasso con mensole in vetro
 Recessed modul with glass shelves
 35 x 160H x 15 cm

**A80760**

Modulo da semincasso con portabicchiere e spandisapone
 Half built-in modul with tumbler holder and soap dispenser
 35 x 26H x 15 cm

**A8086A**

Modulo da semincasso con portarotolo e portascopino My love
 Half built-in modul with paper holder and My love toilet brush holder
 19 x 66H x 15 cm

**A8086C**

Modulo da semincasso con portarotolo, portarotolo di scorta e My Love
 Half built-in modul with paper holder, spare roll holder and My Love
 19 x 86H x 15 cm



A8036A

Modulo da semincasso con
mensole in vetro, anta battente con
specchio interno
Half built-in modul with glass
shelves, pivot door with internal
mirror
35 x 160H x 15 cm

**A8036B**

Modulo da semincasso
con mensole in vetro,
portasciugacapelli, anta battente
con specchio interno
Half built-in modul with glass
shelves, hairdryer holder, pivot
door with internal mirror
35 x 160H x 15 cm

**A8036C**

Modulo da semincasso con
mensole in vetro
Half built-in modul with glass
shelves
35 x 160H x 15 cm

**A8037A**

Modulo esterno con mensole in
vetro, anta battente con specchio
interno
External modul with glass
shelves, pivot door with internal
mirror
35 x 160H x 15 cm

**A8037B**

Modulo esterno con mensole in
vetro, portasciugacapelli, anta
battente con specchio interno
External modul with glass shelves,
hairdryer holder, pivot door with
internal mirror
35 x 160H x 15 cm

**A8037C**

Modulo esterno con mensole in
vetro
External modul with glass shelves
35 x 160H x 15 cm



A8038A

Modulo esterno con mensole in vetro, anta battente con specchio interno
 External modul with glass shelves, pivot door with internal mirror
 35 x 160H x 15 cm

**A8038B**

Modulo esterno con mensole in vetro, portasciugacapelli, anta battente con specchio interno
 External modul with glass shelves, hairdryer holder, pivot door with internal mirror
 35 x 160H x 15 cm



INDISSIMA

Immediate functionality and essential design.

Una serie versatile e pratica ma allo stesso tempo sofisticata e di grande personalità, pensata per caratterizzare l'ambiente bagno in ogni sua declinazione, grazie alle diverse finiture e all'unione di materiali differenti.

A versatile and practical serie but at the same time sophisticated and of great personality, designed to characterize the bathroom environment in all its forms, thanks to the different finishes and the combination of different materials.





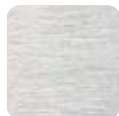

NS
Acciaio inox spazzolato AISI 304
Brushed stainless steel AISI 304



NE
Acciaio inox nero opaco AISI 304
Matt black stainless steel AISI 304



WM
Acciaio inox bianco opaco AISI 304
Matt white stainless steel AISI 304



HPL
Textil ice



HPL
Textil grey

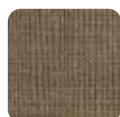

HPL
Textil brown



HPL
Fiore bianco



HPL
Larice panna



HPL
Larice sand

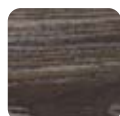

HPL
Larice brown

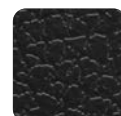

HPL
Fiore nero

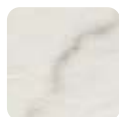

HPL
Calacatta



HPL
Porfido



HPL
Pietra scura

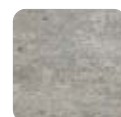

HPL
Yard



HPL
Malta

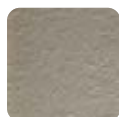

HPL
Pietra chiara



HPL
Cemento scuro



HPL
Lava

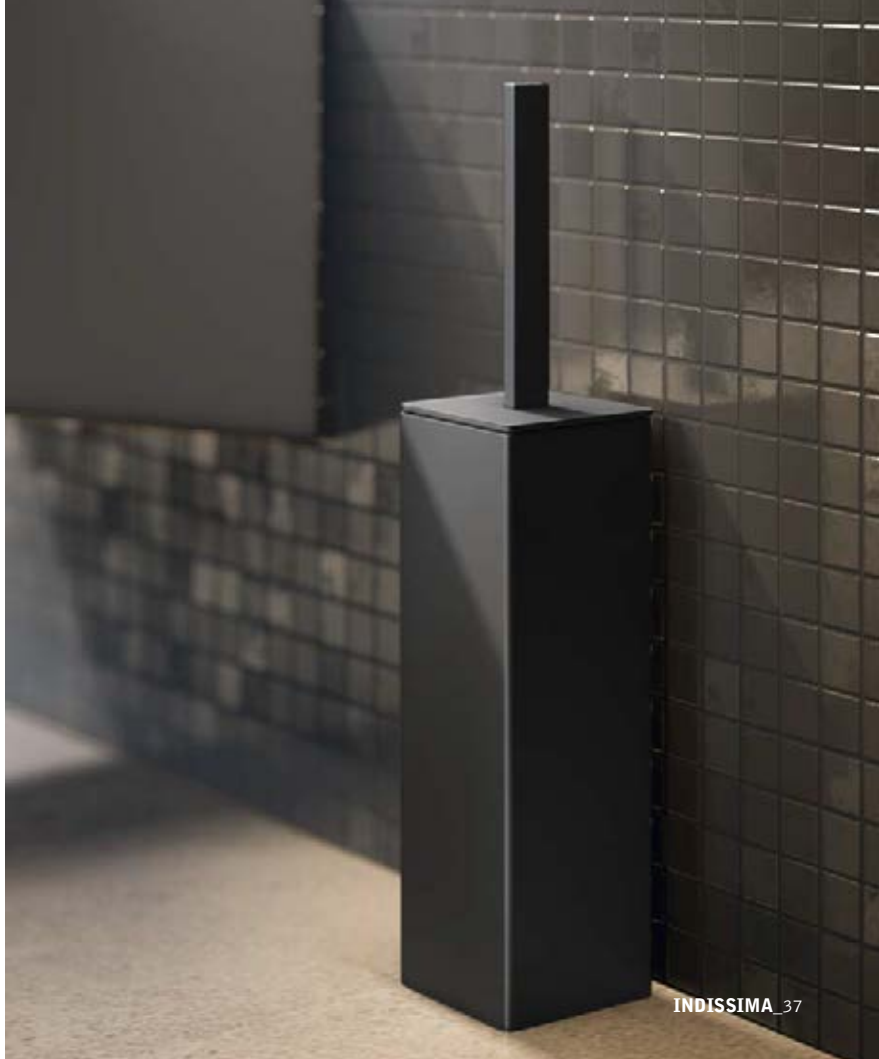
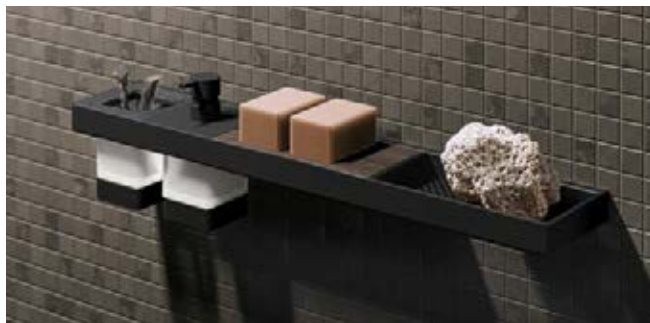



38_INDISSIMA













A8883

Barra modulare
 Modular bar
 20 / 30 / 40 / 60 / 80 / 100 x 3H x 11 cm

**A8883**

Barra modulare con luce led, adatta per
 posizionamento sotto specchio
 Modular bar with led light, suitable for positioning
 under the mirror
 60 / 80 / 100 / 120 / 140 / 160 x 3H x 14 cm

**A8818**

Modulo portasalviette
 Towel holder module
 30 / 40 / 60 / 80 x 3H x 10 cm

**A8812M**

Modulo spandisapone
 Soap spreading module
 10 x 15H x 10 cm



0,25 Lt.

**A8867M**

Modulo spandisapone a leva
 Soap dispenser module with lever
 10 x 12H x 10 cm



0,18 Lt.

**A8810M**

Modulo bicchiere
 Glass module
 10 x 11H x 10 cm

**A8809**

Modulo mensola bassa
 Low shelf module
 20 / 40 x 3H x 10 cm



HPL

A8809

Modulo mensola
 Shelf module
 20 / 40 x 3H x 10 cm



HPL

A8851N
Modulo cestino basso
Low basket module
20 x 3H x 10 cm



A8851M
Modulo cestino
Basket module
20 x 3H x 10 cm



A8826
Modulo portarotolo destro o sinistro con coperchio
Right or left roll holder module with lid
20 x 10H x 10 cm



A8842M
Modulo porta sacchetti igienici
Hygienic bag holder module
10 x 3H x 10 cm

HPL



A8801M
Modulo gettacarta
Paper basket module
20 x 25H x 10 cm



3,5 Lt.

A8814M
Modulo portascopino con fondello estraibile
Brush holder module with removable bottom
10 x 40H x 10 cm



A8818

Portasalviette
Towel holder
42 / 62 / 82 x 3H x 7 cm



click



A88680

Portateili
Bath towel rack
62 x 3H x 23 cm



A8820A

Appendiabiti
Clothes hanger
4 x 3H x 3 cm



A8825

Portarotolo destro o sinistro
Right or left roll holder
15 x 3H x 10 cm



A88510

Cestino
Basket
22 x 3H x 10 cm

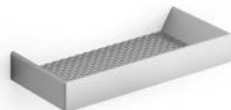

click

AV114

Portascopino da parete/da appoggio
Wall mounted/free-standing toilet brush hold
9 x 40H x 9 cm





INDISSIMA CHROME

Precise and refined geometries.

Un'accurata selezione di accessori Indissima anche in finitura cromata, perfetta per adattarsi facilmente a tutte le stanze da bagno dallo stile moderno e minimale.

A rigorous selection of Indissima accessories also in a chrome finish, perfect for easily adapting to any bathroom with a modern and minimal style.





INDISSIMA CHROME_49



CR
Cromato
Chrome-plated



A8818
Portasalviette
Towel holder
42 / 62 / 82 x 3H x 7 cm



click

A88680
Portateli
Bath towel rack
62 x 3H x 23 cm



A8820A
Appendiabiti
Clothes hanger
4 x 3H x 3 cm



A88670
Spandisapone a leva
Soap dispenser with lever
7 x 12H x 10 cm



click

0,18 Lt.

A88120
Spandisapone
Soap dispenser
7 x 15H x 10 cm



click

0,25 Lt.

A88100
Portabicchiere
Tumbler holder
7 x 10H x 10 cm



click

A88110
Portasapone
Soap holder
12 x 4H x 12 cm



click

A8825
Portarotolo
Paper holder
15 x 3H x 10 cm



A88510
Cestino
Basket
22 x 3H x 10 cm



click

AV114A
Portascopino da parete/da appoggio
Wall mounted/free-standing toilet brush holder
9 x 40H x 9 cm



GEALUNA

Elegance matches rigorous design.

Un'estetica estremamente essenziale e di grande eleganza, con l'utilizzo di materiali di assoluta qualità, è la caratteristica principale di Gealuna, una collezione dal design rigoroso, distinto da linee nette e pulite. La serie può essere montata a parete utilizzando la colla per evitare la foratura delle ceramiche oppure con viti e tasselli.

An extremely essential look and of great elegance with the use of absolute top quality materials. Gealuna rigorous design, stands out for its clean, sharp lines. The series can be mounted to the wall using glue does not require to make a hole of ceramics or with screws and dowels.





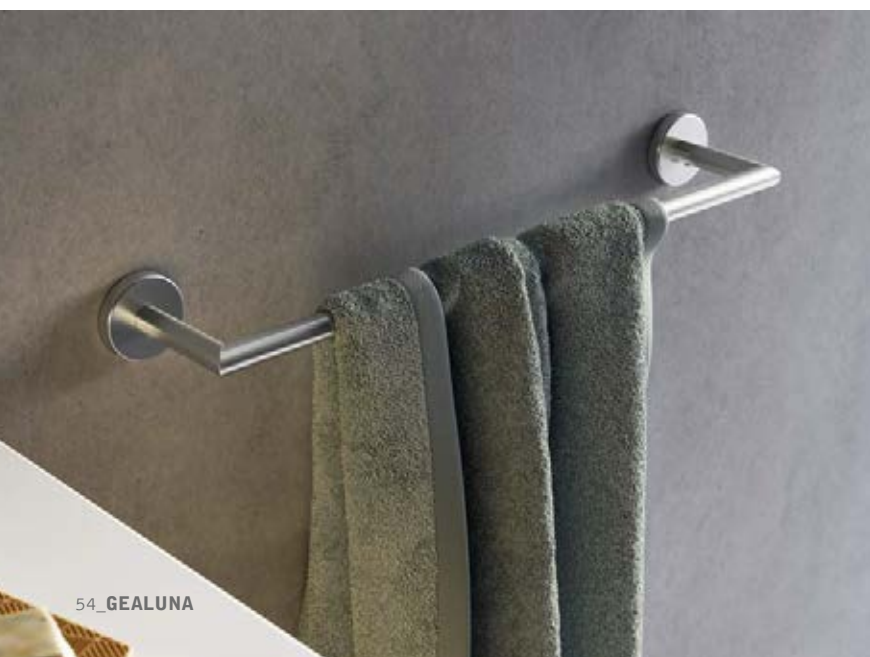





CR
Cromato
Chrome-plated

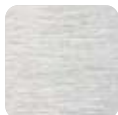

AS
Acciaio inox satinato AISI 304
Satin stainless steel AISI 304

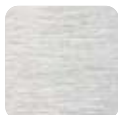

NS
Acciaio inox spazzolato AISI 304
Brushed stainless steel AISI 304





A1018

Portasalviette
Towel holder
35 / 50 / 65 / 85 x 5H x 9 cm



click

**A1018**

Portasalviette senza placca a muro
Towel holder without wall plate
32 / 47 / 62 / 82 x 2H x 9 cm



click

A10150

Portasalviette doppio a snodo
Double swing arm towel holder
5 x 9H x 37 cm

**A1019**

Portasalviette doppio
Double towel holder
50 / 65 x 5H x 12 cm



click

**A1019**

Portasalviette doppio senza placca a muro
Double towel holder without wall plate
47 / 62 x 2H x 12 cm



click

A10160

Portasalviette ad anello
Ring towel holder
18 x 20H x 6 cm



click

**A10680**

Portateli con portasalviette
Bath towel rack with towel holder
60 x 12H x 29 cm

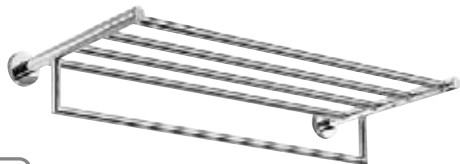

click

A1020A

Appendiabiti
Clothes hanger
5 x 5H x 6 cm



click

**A1020B**

Appendiabiti doppio
Double clothes hanger
15 x 5H x 5 cm

**A1020C**

Appendiabiti
Clothes hanger
7 x 5H x 6 cm





A1010N
Anello supporto a parete
Wall support
8 x 5H x 12 cm



click



R46100001
Bicchiere in vetro trasparente extra chiaro
Tumbler in extra clear transparent glass
8 x 11H x 8 cm



R46110001
Bacinella in vetro trasparente extra chiaro
Dish in extra clear transparent glass
13 x 4H x 13 cm



0,25 Lt.

A1112A
Spandisapone in vetro trasparente con erogatore, erogatore in finitura
Soap dispenser in transparent glass with pump in finish brass pump
8 x 15H x 9 cm



A1025
Portarotolo
Paper holder
18 x 5H x 9 cm



click



A1025B
Portarotolo basculante
Tilting roll holder
14 x 10H x 6 cm



click



A1025C
Portarotolo doppio
Double paper holder
29 x 5H x 9 cm



click



A10260
Portarotolo basculante con coperchio
Tilting roll holder with cover
16 x 15H x 6 cm



click



A10280
Portarotolo di scorta
Spare roll holder
5 x 18H x 9 cm



click



A1031B
Angolare
Corner
21 x 2H x 21 cm



A1051B
Cestino
Basket
29 x 3H x 13 cm



A10950
Maniglione di sicurezza
Safety grip
36 x 5H x 6 cm



1,500N
~150Kg

A1095
Maniglione di sicurezza
Safety grip
51 / 66 x 5H x 6 cm



1,500N
~150Kg

AV014

Portascopino da parete/da appoggio.
Scovolo di ricambio incluso
Wall mounted/free-standing toilet brush holder.
Spare brush included
9 x 40H x 9 cm

**R10000**

Adesivo in pasta
Paste adhesive

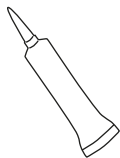

MITO

Simplicity and refinement.

Mito è una serie di accessori in ottone cromato indicata per arredare con semplicità ed eleganza. Grazie ad un innovativo sistema di fissaggio a "scatto", il montaggio a parete viene estremamente facilitato.

Mito is a series of accessories in chromium plated brass to furnish with simplicity and elegance; thanks to an innovative fixing system "clip", the wall assembly is extremely facilitated.





click 



64_MITO





A2018

Portasalviette
Towel holder
34 / 49 / 64 / 84 x 2H x 8 cm



click

A20150

Portasalviette doppio a snodo
Double swing arm towel holder
2 x 9H x 40 cm

**A20160**

Portasalviette ad anello
Ring towel holder
28 x 16H x 8 cm



click

A2020A

Appendiabiti
Clothes hanger
2 x 6H x 4 cm



click

A2020B

Appendiabiti doppio
Double clothes hanger
9 x 3H x 4 cm



click

A2010N

Anello supporto a parete
Wall support ring
8 x 2H x 12 cm



click

R00100007

Bicchieri in vetro satinato per anello
supporto A2010N
Satin glass for A2010N support ring
8 x 10H x 8 cm

**R46110**

Bacinella in vetro satinato per anello
supporto A2010N
Satin cup for A2010N support ring
13 x 4H x 13 cm

**A2012A**

Spandisapone in vetro satinato con
erogatore in finitura
Brushed glass soap dispenser with
dispenser in finishing
8 x 15H x 9 cm



0,25 Lt.

A20010

Portabicchiere da appoggio con
bicchiere in vetro satinato
Tabletop tumbler holder with satinated
glass tumbler
8 x 10H x 8 cm

**A20020**

Portasapone da appoggio con
bicchiere in vetro satinato
Tabletop soap holder with satinated
glass tumbler
13 x 5H x 13 cm

**A20060**

Spandisapone da appoggio, con
contenitore in vetro satinato ed erogatore
in finitura
Tabletop soap dispenser with satinated glass
container and pump in finishing
8 x 16H x 9 cm



0,25 Lt.

A2025
Portarotolo
Paper holder
17 x 3H x 8 cm



click

A20260
Portarotolo basculante con coperchio
Tilting roll holder with cover
15 x 9H x 5 cm



click

A2028A
Portarotolo di scorta
Spare roll holder
2 x 16H x 8 cm



click

AV114
Portascopino da parete/da appoggio
Wall mounted/free-standing toilet brush holder
9 x 40H x 9 cm



AV014
Portascopino da parete/da appoggio.
Scovolo di ricambio incluso
Wall mounted/free-standing toilet brush holder.
Spare brush included
9 x 40H x 9 cm



DIVO

Pragmatic and essential design.

Divo è una serie di accessori dal carattere forte e deciso, espressione di un design pragmatico ed essenziale che si esprime attraverso linee pulite e squadrate. L'assenza della placca di fissaggio a muro diventa espressione di un gusto contemporaneo minimale che si esprime con un "segno" che caratterizza lo spazio.

Divo is a serie of accessories with strong character, expression of a pragmatic and essential design that is expressed through clean and squared lines. The absence of the fixing plaque to the wall becomes an expression of a contemporary minimalist taste which is expressed by a "sign" that characterizes the space.







CR
Cromato
Chrome-plated



AC
Nickel spazzolato
Brushed nickel

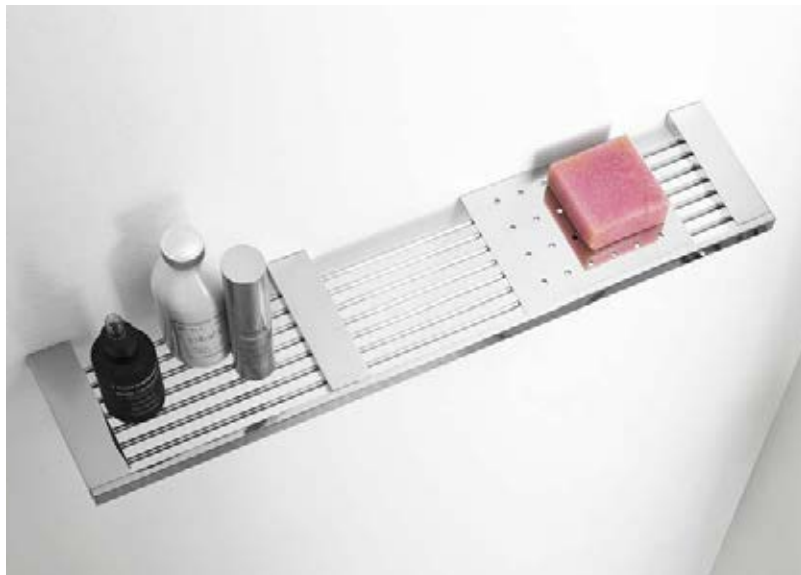



A1518

Portasalviette
Towel holder
32 / 47 / 62 / 82 x 2H x 9 cm

**A15150**

Portasalviette doppio a snodo
Double swing arm towel holder
2 x 8H x 39 cm

**A2010Z**

Portabicchiere da appoggio con
bicchiere in vetro
Tabletop tumbler holder with glass
tumbler
9 x 11H x 9 cm

**A2011Z**

Portasapone da appoggio con
bacinella in vetro
Tabletop soap holder with glass
dish
11 x 4H x 11 cm

**A2012Z**

Spandisapone da appoggio, con
contenitore in vetro ed erogatore in finitura
Tabletop soap dispenser with glass
container and pump in finishing
9 x 16H x 9 cm



0,25 Lt.

**A1510N**

Anello supporto a parete
Wall support ring
11 x 2H x 11 cm

**R1510B**

Bicchiere
Tumbler
8 x 11H x 8 cm

**R1511B**

Bacinella
Dish
11 x 4H x 11 cm

**R1512B**

Spandisapone
Soap dispenser
8 x 16H x 9 cm



0,25 Lt.

**A1520A**

Appendiabiti
Clothes hanger
2 x 8H x 3 cm

**A1525A**

Portarotolo
Paper holder
18 x 2H x 9 cm

**A1525B**

Portarotolo
Paper holder
18 x 2H x 9 cm



A15490

Cestino
Basket
21 x 2H x 11 cm

**A15510**

Cestino con ripiano asportabile
Basket with removable shelf
52 x 2H x 11 cm

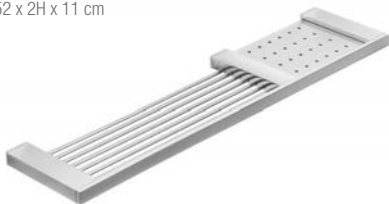
**AV114**

Portascopino da parete/da appoggio
Wall mounted/free-standing toilet brush holder
9 x 40H x 9 cm



LEA

Accessories for every need.

Lea, funzionalità essenziale. Voglia di nuove geometrie con la purezza della forma a sezione rettangolare, un sistema completo di accessori che soddisfa, con proposte mirate, tutte le esigenze e le funzioni dell'arredobagno!

La serie può essere montata a parete utilizzando il kit da incollare per evitare la foratura delle ceramiche oppure con viti e tasselli.

Lea, essential functionality. Desire for new geometries with the purity of a rectangular section form, a complete system of accessories that meets with specific proposals the needs and functions of bathroom design! The series can be wall-mounted using the glue from the kit to avoid drilling of ceramics or installed with screws and dowels.







76_LEA







CR
Cromato
Chrome-plated



CF
Cromo nero lucido
Glossy black chrome

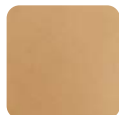

OR
Oro rosato lucido
Glossy rose-coloured gilded



DR
Dorato 24 carati
Gilded 24 carats



WM
Bianco opaco
Matt white



AC
Nickel spazzolato
Brushed nickel



CG
Cromo nero spazzolato
Brushed black chrome



OS
Oro rosato spazzolato
Brushed rose-coloured gilded

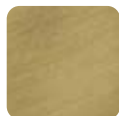

BZ
Bronzo
Bronzed



NE
Nero opaco
Matt black





R1800N

Kit fissaggio a parete opzionale.
 Include confezione colla
 Optional wall mounting kit.
 Includes glue pack
 6 x 3H x 1 cm

**A1818**

Portasalviette
 Towel holder
 36 / 51 / 66 / 86 x 3H x 8 cm

**A1819**

Portasalviette doppio
 Double towel holder
 51 / 66 x 3H x 13 cm

**A1815**

Portasalviette fisso a bandiera
 Flag fixed towel holder
 6 x 3H x 32 / 45 cm

**A1815A**

Portasalviette doppio a snodo
 Double swing arm towel holder
 7 x 4H x 37 cm

**A18160**

Portasalviette ad anello
 Ring towel holder
 22 x 14H x 6 cm

**A18680**

Portateli con portasalviette
 Bath towel rack with towel holder
 66 x 9H x 25 cm

**A1820A**

Appendiabiti
 Clothes hanger
 6 x 3H x 5 cm

**A1820B**

Appendiabiti doppio
 Double clothes hanger
 11 x 3H x 5 cm

**A1820C**

Appendiabiti triplo
 Triple clothes hanger
 17 x 3H x 5 cm



A1810Z

Portabicchiere da appoggio con bicchiere in vetro satinato
Tabletop tumbler holder with satined glass tumbler
7 x 10H x 7 cm



0,25 Lt.

A1812Z

Spandisapone da appoggio, con contenitore in vetro satinato ed erogatore in finitura
Tabletop soap dispenser with satined glass container and pump in finishing
7 x 15H x 8 cm

**A1811Z**

Portasapone da appoggio con bacinella in vetro satinato
Tabletop soap holder with satined glass dish
12 x 4H x 12 cm

**A18100**

Portabicchiere a parete con bicchiere in vetro satinato
Wall-mounted tumbler holder with satined glass tumbler
7 x 11H x 11 cm

**A181670**

Spandisapone a leva
Soap dispenser with lever
7 x 11H x 11 cm



0,18 Lt.

**A18120**

Spandisapone a parete con contenitore in vetro satinato, erogatore in finitura
Wall-mounted soap dispenser with satined glass container and in finish brass pump
7 x 15H x 12 cm



0,25 Lt.

**A18110**

Portasapone a parete con bacinella in vetro satinato
Wall-mounted soap holder with satined glass dish
12 x 5H x 13 cm

**A1810D**

Supporto doppio a parete con bicchiere e spandisapone in vetro satinato, erogatore in finitura
Wall-mounted double support with satined glass tumbler and soap dispense in finish brass pump
20 x 15H x 12 cm



0,25 Lt.

A1810F

Portabicchiere a parete con 2 bicchieri in vetro satinato
Wall-mounted tumbler holder with 2 satined glass tumblers
20 x 11H x 11 cm



A1825
Portarotolo
Paper holder
19 x 3H x 8 cm



A1825B
Portarotolo doppio
Double paper holder
31 x 3H x 8 cm



A18260
Portarotolo basculante con
copercchio
Tilting roll holder with cover
15 x 10H x 5 cm



A1826A
Portarotolo con copercchio
Paper holder with cover
17 x 2H x 13 cm



A18280
Portarotolo di scorta
Spare roll holder
6 x 17H x 8 cm



A18310
Angolare
Corner
16 x 7H x 17 cm

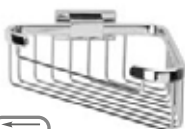

A18510
Cestino
Basket
20 x 7H x 12 cm



A1849A
Cestino
Basket
15 x 3H x 10 cm



A1851A
Cestino
Basket
25 x 3H x 12 cm



A18090
Mensola in cristallo satinato temperato 6
mm con supporti
Tempered satinated crystal shelf, 6 mm
glass, with brackets
60 x 3H x 13 cm



A18140
Portascopino da parete con bacinella in
vetro satinato
Wall-mounted toilet brush holder, with
satinated glass dish
10 x 35H x 13 cm





ONE

Simply unique.

La semplicità ha un nuovo nome: One. La collezione di accessori per il bagno disegnata da Matteo Thun e Antonio Rodriguez combina elementi lineari e puliti. La vastità dell'assortimento e la chiarezza formale rendono One una soluzione particolarmente flessibile sia dal punto di vista stilistico che pratico. La collezione One si adatta sia ad ambienti pubblici che residenziali.

Simplicity has a new name: One. The collection of bathroom accessories designed by Matteo Thun and Antonio Rodriguez combines linear and clean elements. The vastness of the assortment and formal clarity make One a very flexible solution from the point of view of style and practicality. The One collection is suitable for both commercial and residential environments.





click 

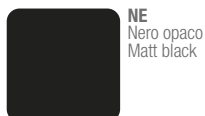
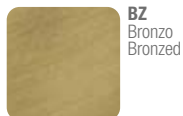
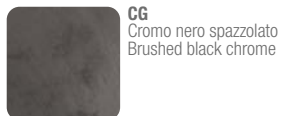
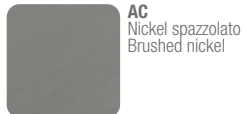







A2490

Portasalviette
Towel holder
35 / 50 / 65 / 85 x 5H x 7 cm

**A2491C**

Portasalviette doppio
Double towel holder
65 x 5H x 12 cm

**A2415A**

Portasalviette fisso a bandiera
Flag fixed towel holder
5 x 5H x 35 cm

**A2415B**

Portasalviette doppio a snodo
Double swing arm towel holder
5 x 5H x 37 cm

**A2416A**

Portasalviette ad anello
Ring towel holder
22 x 23H x 3 cm

**A24680**

Portateli con portasalviette
Bath towel rack with towel holder
65 x 12H x 30 cm

**AV120A**

Appendiabiti
Clothes hanger
4 x 4H x 4 cm

**AV120B**

Appendiabiti doppio
Double clothes hanger
4 x 7H x 4 cm



click

**AV120C**

Appendiabiti triplo
Triple clothes hanger
25 x 4H x 4 cm



click

**AV120D**

Appendiabiti quadruplo
Quaduple clothes hanger
42 x 4H x 4 cm



click



A2410A

Portabicchiere a parete con bicchiere in vetro extrachiaro trasparente
 Wall-mounted tumbler holder with extra clear transparent glass tumbler
 8 x 11H x 12 cm

**A24110**

Portasapone a parete con bacinella in vetro extrachiaro trasparente
 Wall-mounted soap holder with extra clear transparent glass dish
 13 x 5H x 14 cm

**A24120**

Spandisapone a parete con contenitore in vetro extrachiaro trasparente, erogatore in finitura
 Wall-mounted soap dispenser with extra clear transparent glass container and in finish brass pump
 8 x 16H x 12 cm



0,25 Lt.

A24250

Portarotolo
 Paper holder
 17 x 5H x 9 cm

**A24260**

Portarotolo con coperchio
 Paper holder with cover
 14 x 8H x 13 cm

**A24280**

Portarotolo di scorta
 Spare roll holder
 5 x 5H x 13 cm

**AV014**

Portascopino da parete/da appoggio.
 Scovolo di ricambio incluso
 Wall mounted/free-standing toilet brush holder.
 Spare brush included
 9 x 40H x 9 cm



LOGIC

Between design and practicality.

Funzionalità, autenticità, concretezza e innovazione sono valori che solo Inda può dare e ci riesce anche con questa serie di Accessori, dove la matrice progettuale ha utilizzato volumi essenziali e linee pure per mediare tra design e funzionalità. La collezione Logic, una serie completa di oggetti eleganti e funzionali destinata all'ambiente bagno contemporaneo, offre perfezione esecutiva e qualità dei materiali.

Functionality, authenticity, concreteness and innovation are values that only Inda can give and it succeeds also with this series of accessories, where the planning matrix has used essential volumes and pure lines to mediate between design and functionality. The collection Logic, a complete series of objects elegant and functional destined to the contemporaneous bathroom environment, offers executive perfection and quality of materials.





click



CR
Cromato
Chrome-plated



NE
Nero opaco
Matt black



94_LOGIC





A5518
Portasalviette
Towel holder
35 / 50 / 65 / 80 x 3H x 8 cm



click

A55150
Portasalviette doppio a snodo
Double swing arm towel holder
6 x 4H x 38 cm



A55160
Portasalviette ad anello
Ring towel holder
22 x 14H x 8 cm



click

A55510
Cestino
Basket
25 x 3H x 15 cm

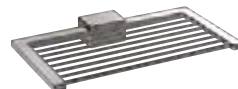

click

A5520
Appendiabiti
Clothes hanger
3 x 6H x 4 / 4 x 8H x 3 cm



click

A49200
Appendiabiti
Clothes hanger
4 x 3H x 5 cm



click

A5510N
Anello supporto a parete
Wall support ring
9 x 2H x 11 cm



click

A5510Z
Anello supporto da appoggio
Support ring
9 x 2H x 9 cm



click

R1510B
Bicchieri
Tumbler
8 x 11H x 8 cm



click

R1511B
Bacinella
Dish
11 x 4H x 11 cm



96_LOGIC

R1512B
Spandisapone
Soap dispenser
8 x 16H x 9 cm



0,25 Lt.

A5525A
Portarotolo
Paper holder
18 x 4H x 8 cm



click

A5525C
Portarotolo doppio
Double paper holder
30 x 4H x 8 cm



click

A5527A
Portarotolo con coperchio
portacellulare
Toilet roll holder with mobile
phone holder
17 x 10H x 12 cm



click

A33950

Maniglione di sicurezza
Safety grip
30 x 3H x 5 cm



1.500N
~150Kg

**A3395**

Maniglione di sicurezza
Safety grip
45 / 60 x 3H x 5 cm



1.500N
~150Kg

**A33920**

Maniglione di sicurezza
Safety grip
37 x 17H x 5 cm



1.500N
~150Kg

**A33850**

Piantana con 2 portasalviette
Stand with 2 towel holders
24 x 88H x 40 cm

**AV114**

Portascopino da parete/da appoggio
Wall mounted/free-standing toilet brush holder
9 x 40H x 9 cm



TOUCH

Rounded solid design.

Touch: una gamma pensata per offrire un'ampia scelta sia in fatto di servizio che di tipologia compositiva, una gamma particolarmente articolata per una serie completa di accessori bagno.

Touch: a range designed to offer a large selection choice both in terms of service and composition type, a range particularly articulated to a complete range of bathroom accessories.





TOUCH_99



100_TOUCH



CR
Cromato
Chrome-plated





A4618A
Portasalviette
Towel holder
32 x 5H x 8 cm



A4618
Portasalviette
Towel holder
51 / 66 x 5H x 8 cm



A4618
Portasalviette
Towel holder
32 / 51 / 66 / 81 x 5H x 8 cm



A4618U
Portasalviette
Towel holder
60 x 2H x 8 cm



A46150
Portasalviette doppio a snodo
Double swing arm towel holder
6 x 6H x 39 cm

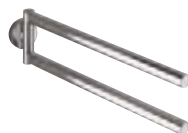

A46160
Portasalviette ad anello
Ring towel holder
22 x 24H x 8 cm



A46200
Appendiabiti
Clothes hanger
5 x 5H x 5 cm



A46210
Appendiabiti doppio
Double clothes hanger
8 x 5H x 6 cm



A4610Z
Portabicchiere da appoggio con
bicchiere in vetro satinato
Tabletop tumbler, with satined glass
tumbler
8 x 14H x 8 cm



A4611Z
Portasapone da appoggio con
bacinella in vetro satinato
Tabletop soap holder with satined
glass dish
13 x 7H x 13 cm



A4667Z
Spandisapone da appoggio con
contenitore in vetro satinato, erogatore in
ottone cromato
Tabletop soap dispenser with satined glass
container and chrome-plated brass pump
8 x 19H x 9 cm

0,25 Lt.



A46100

Portabicchiere a parete con
bicchiere in vetro satinato
Wall-mounted tumbler holder with
satinated glass tumbler
8 x 11H x 12 cm

**A46110**

Portasapone a parete con bacinella in
vetro satinato
Wall-mounted soap holder with satinated
glass dish
13 x 5H x 15 cm

**A4611M**

Portasapone a parete con bacinella in
ottone cromato
Wall-mounted soap holder, with
chrome-plated brass dish
11 x 5H x 12 cm

**A46670**

Spandisapone a parete con contenitore in
vetro satinato, erogatore in ottone cromato
Wall-mounted soap dispenser with satinated
glass container and chrome-plated brass
pump
8 x 15H x 13 cm



0,25 Lt.

A4625

Portarotolo
Paper holder
18 x 5H x 8 cm

**A46252**

Portarotolo doppio
Double paper holder
38 x 5H x 8 cm

**A4626B**

Portarotolo basculante con coperchio
Tilting roll holder with cover
15 x 11H x 5 cm

**A46280**

Portarotolo di scorta
Spare roll holder
5 x 18H x 8 cm

**A46510**

Cestino
Basket
35 x 6H x 13 cm

**A46080**

Mensola in cristallo satinato temperato
6 mm con supporti
Tempered satinated crystal shelf, 6 mm
glass, with brackets
60 x 5H x 15 cm

**A4690M**

Maniglione di sicurezza
Safety grip
30 x 5H x 6 cm

1.200N
~120Kg**AV014**

Portascopino da parete/da appoggio.
Scovolo di ricambio incluso
Wall mounted/free-standing toilet brush holder.
Spare brush included
9 x 40H x 9 cm







EGO

Executive perfection and wide adaptaility.

Ego è una serie che si integra con l'ambiente bagno attraverso le caratteristiche di praticità, servizio e perfezione esecutiva. Una serie di accessori progettata secondo le esigenze legate soprattutto all'hotellerie, ma perfettamente adattabile anche all'ambito domestico, grazie alla purezza formale e alla ricerca tecnica di durabilità e igiene.

Ego is a collection that is integrated with the bathroom environment through the practicality, characteristics service and executive perfection. A series of accessories designed according to the requirements associated with the hotel industry in particular, but also perfectly adaptable to the domestic scope, thanks to the purity of form and technical research of durability and hygiene.





CR
Cromato
Chrome-plated



AL
Acciaio inox AISI 304
Stainless steel AISI 304



NE
Nero opaco
Matt black





A1318

Portasalviette
Towel holder
33 / 48 / 63 x 3H x 8 cm

**A13680**

Portateli con portasalviette
Bath towel rack with towel holder
62 x 16H x 28 cm

**A13010**

Gettacarta con base antiscivolo
Waste basket with anti-slip base
22 x 24H x 22 cm



7 Lt.

**A1320A**

Appendiabiti
Clothes hanger
3 x 3H x 4 cm

**A1320B**

Appendiabiti
Clothes hanger
3 x 3H x 7 cm

**A1320C**

Appendiabiti doppio
Double clothes hanger
3 x 6H x 4 cm

**A1331A**

Angolare
Corner
18 x 4H x 18 cm

**A1351A**

Cestino
Basket
27 x 4H x 11 cm

**A20110**

Portasapone a parete con bacinella in vetro satinato
Wall-mounted soap holder with satinated glass dish
13 x 4H x 14 cm



click

A20100

Portabicchiere a parete con bicchiere in vetro satinato
Wall-mounted tumbler holder with satinated glass tumbler
8 x 10H x 12 cm



click

A20120

Spandisapone a parete con contenitore in vetro satinato, erogatore in ottone cromato
Wall-mounted soap dispenser with satinated glass container and chrome-plated brass pump
8 x 15H x 12 cm



0,25 Lt.

click

A1325

Portarotolo
Paper holder
16 x 7H x 9 cm

**A1328A**

Portarotolo di scorta
Spare roll holder
3 x 16H x 8 cm

**A13950**

Maniglione di sicurezza
Safety grip
35 x 3H x 7 cm



1.500N
~150Kg

A1390

Maniglione di sicurezza
Safety grip
50 / 65 x 3H x 7 cm



1.200N
~120Kg

AV014

Portascopino da parete/da appoggio.
Scovolo di ricambio incluso
Wall mounted/free-standing toilet brush holder.
Spare brush included
9 x 40H x 9 cm



AVENUE

The harmony of materials.

Dai spazio alla tua immaginazione con la nuova serie Avenue di Inda. La tecnica costruttiva si evolve, disegnando nuove proporzioni e dettagli tecnici distintivi. Le nuove finiture, i toni ed i materiali scelti con una ricerca accurata si fondono insieme in una proposta attraente e autentica di grande appeal.

Give free rein to your imagination with the new collection series Avenue from Inda. The construction technology evolves designing new proportions and distinctive technical details. The new finishings, the colour hues and the materials chosen with an accurate research merge in an attractive and genuine proposal of great appeal.







DL
Cromato/smoke
Chrome-plated/smoke



CA
Cromato/miel
Chrome-plated/miel



114_AVENUE





A5790
Portasalviette
Towel holder
38 / 53 / 68 x 4H x 9 cm



A57200
Appendiabiti
Clothes hanger
8 x 9H x 6 cm



A57250
Portarotolo
Paper holder
14 x 13H x 10 cm



A57090
Mensola
Shelf
30 x 7H x 13 cm



A5711Z
Portasapone da appoggio con
bacinella in vetro satinato
Tabletop soap holder with satinated
glass dish
13 x 5H x 11 cm



A5710Z
Portabicchiere da appoggio con
bicchiere in vetro satinato
Tabletop tumbler holder with satinated
glass tumbler
13 x 13H x 11 cm



A5712Z
Spandisapone da appoggio con
contenitore in vetro satinato,
erogatore in ottone cromato
Tabletop soap dispenser with satinated
glass container and chrome-plated
brass pump
13 x 18H x 11 cm



0,25 Lt.

A5783A
Mensola a "S"
S shaped shelf
36 x 45H x 13 cm



A5783B
Mensola portaoggetti
Multipurpose shelf
32 x 113H x 13 cm



A57850
Piantana con portarotolo, portariviste e portacellulare
Floor lamp with roll holder, magazine rack and mobile phone holder
26 x 73H x 16 cm



A57140
Portascopino da parete/da appoggio
Wall mounted/free-standing toilet brush holder
9 x 43H x 9 cm





RAFFAELLA

Tradition, timeless past and quality materials.

La serie Raffaella interpreta con eloquenza canoni tradizionali e sapori di un passato senza tempo, che affonda le proprie radici in forme di antica memoria. Le finiture e la qualità dei materiali proposti si rifanno alla tradizione, sottolineando con il loro stile la cura del dettaglio.

The serie Raffaella interprets with eloquence traditional canons and tastes of a timeless past which has its roots in old memory forms. The finishing and the quality of the materials proposed are based on tradition, underlining with their style the attention to the detail.







CR
Cromato
Chrome-plated



CD
Cromato/dorato
Chrome-plated/gilded



DR
Dorato 24 carati
Gilded 24 carats



BZ
Bronzo
Bronzed

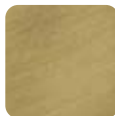



A3218

Portasalviette
Towel holder
42 / 57 / 72 x 6H x 9 cm

**A32150**

Portasalviette doppio a snodo
Double swing arm towel holder
6 x 10H x 48 cm

**A32160**

Portasalviette ad anello
Ring towel holder
23 x 17H x 9 cm

**A32500**

Cestino
Basket
27 x 6H x 14 cm

**A32680**

Portateli
Bath towel holder
56 x 9H x 25 cm

**A32200**

Appendiabiti doppio
Double clothes hanger
13 x 7H x 9 cm

**A32100**

Portabicchiere a parete con bicchiere
in vetro satinato o in ceramica bianca
Wall-mounted tumbler holder with
satined glass or white ceramic
tumbler
15 x 9H x 12 cm

**A32110**

Portasapone a parete con bacinella in
vetro satinato o in ceramica bianca
Wall-mounted soap holder with
satined glass or white ceramic dish
17 x 6H x 14 cm

**A32120**

Spandisapone a parete con contenitore in
vetro satinato, erogatore in ottone cromato
Wall-mounted soap dispenser with satin
glass container and chrome-plated
brass pump
15 x 16H x 12 cm

**A32250**

Portarotolo
Paper holder
20 x 6H x 9 cm

**A32260**

Portarotolo
Paper holder
18 x 17H x 9 cm

**A3226A**

Portarotolo con copercio
Paper holder with cover
18 x 17H x 10 cm



0,25 Lt.

A32920

Maniglione con cestino
Grab-bar with basket
42 x 21H x 12 cm

**REV****A32080**

Mensola in cristallo satinato temperato
5 mm
Tempered satinated crystal shelf, 5 mm
glass
72 x 6H x 14 cm

**A37140**

Portascopino da parete/da appoggio
Wall mounted/free-standing toilet brush holder
9 x 45H x 10 cm



FORUM QUADRA

Curved lines meet square shapes.

Linee curve che si integrano a forme squadrate in un design originale e versatile. Una nuova gamma in cui la funzionalità è protagonista.

Curved lines and square shapes are integrated in a creative and versatile design. A new series where functionality becomes the protagonist.







CR
Cromato
Chrome-plated





A3018A
Portasalviette
Towel holder
25 x 5H x 7 cm



A3018
Portasalviette
Towel holder
35 / 50 / 66 / 86 x 5H x 7 cm



A3019C
Portasalviette doppio
Double towel holder
66 x 5H x 13 cm



A3015A
Portasalviette fisso a bandiera
Flag fixed towel holder
7 x 7H x 45 cm



A30150
Portasalviette doppio a snodo
Double swing arm towel holder
8 x 5H x 45 cm



A30160
Portasalviette ad anello
Ring towel holder
18 x 19H x 6 cm



A3020A
Appendiabiti
Clothes hanger
5 x 7H x 7 cm



A3020B
Appendiabiti doppio
Double clothes hanger
7 x 5H x 5 cm



A30100
Portabicchiere a parete con bicchiere
in vetro satinato
Wall-mounted tumbler holder with
satinated glass tumbler
7 x 10H x 12 cm



A3010D
Portabicchiere a parete con 2
bicchieri in vetro satinato
Wall-mounted tumbler holder with 2
satinated glass tumblers
19 x 10H x 10 cm



A30110
Portasapone a parete con bacinella in
vetro satinato
Wall-mounted soap holder with
satinated glass dish
11 x 5H x 14 cm



A30120
Spandisapone a parete con contenitore in
vetro satinato, erogatore in ottone cromato
Wall-mounted soap dispenser with satinated
glass container and chrome-plated
brass pump
7 x 18H x 13 cm



0,25 Lt.

A30250

Portarotolo
Paper holder
18 x 6H x 10 cm

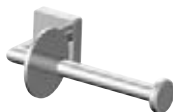
**A3025B**

Portarotolo basculante
Tilting roll holder
14 x 10H x 6 cm

**A30260**

Portarotolo basculante con coperchio
Tilting roll holder with cover
14 x 12H x 7 cm

**A30090**

Mensola in cristallo satinato temperato
6 mm con supporti
Tempered satined crystal shelf, 6 mm
glass, with brackets
57 x 5H x 12 cm

**A30950**

Maniglione di sicurezza
Safety grip
32 x 7H x 7 cm



1.500N
~150Kg

A30140

Portascopino da parete con bacinella in
vetro satinato
Wall-mounted toilet brush holder, with
satined glass dish
11 x 41H x 15 cm



FORUM

A complete and simple collection.

Forum: una gamma completa con un'estetismo essenziale; una serie pensata per offrire un'ampia scelta di prodotti funzionali.

Forum: a complete range with an essential aestheticism, a series designed in order to offer a large range of functional products.







CR
Cromato
Chrome-plated





R000K

Kit fissaggio a parete. Include confezione colla (kit opzionale)
Wall mounting kit. Includes glue pack (optional kit)
6 x 6H x 0,5 cm

**A3618A**

Portasalviette
Towel holder
26 x 6H x 7 cm

**A3618**

Portasalviette
Towel holder
36 / 51 / 67 / 87 x 6H x 7 cm

**A36160**

Portasalviette ad anello
Ring towel holder
18 x 20H x 6 cm

**A3690**

Portasalviette
Towel holder
36 / 51 / 66 x 6H x 8 cm

**A3619C**

Portasalviette doppio
Double towel holder
67 x 6H x 13 cm

**A36150**

Portasalviette doppio a snodo
Double swing arm towel holder
8 x 6H x 46 cm

**A3620A**

Appendiabiti
Clothes hanger
6 x 8H x 7 cm

**A3620B**

Appendiabiti doppio
Double clothes hanger
7 x 6H x 5 cm

**A36100**

Portabicchiere a parete con bicchiere
in vetro satinato
Wall-mounted tumbler holder with
satinated glass tumbler
7 x 10H x 12 cm

**A36100**

Portabicchiere a parete con 2
bicchieri in vetro satinato
Wall-mounted tumbler holder with 2
satinated glass tumblers
19 x 10H x 10 cm

**A36110**

Portasapone a parete con bacinella
in vetro satinato
Wall-mounted soap holder with
satinated glass dish
11 x 6H x 14 cm



A36120

Spandisapone a parete con contenitore in vetro satinato, erogatore in ottone cromato
 Wall-mounted soap dispenser with satinated glass container and chrome-plated brass pump
 7 x 18H x 13 cm



0,25 Lt.

A36920

Maniglione con cestino
 Grab-bar with basket
 43 x 22H x 12 cm

1.500N
~150Kg**A36950**

Maniglione di sicurezza
 Safety grip
 32 x 7H x 7 cm

1.500N
~150Kg**A36250**

Portarotolo
 Paper holder
 19 x 6H x 10 cm

**A3625B**

Portarotolo basculante
 Tilting roll holder
 14 x 10H x 6 cm

**A36260**

Portarotolo basculante con coperchio
 Tilting roll holder with cover
 14 x 14H x 7 cm

**A36090**

Mensola in cristallo satinato temperato
 6 mm con supporti
 Tempered satinated crystal shelf, 6 mm
 glass, with brackets
 58 x 6H x 12 cm

**A36140**

Portascopino da parete con bacinella in vetro satinato
 Wall-mounted toilet brush holder, with
 satinated glass dish
 11 x 41H x 15 cm



COMFORT

Functionality, technology and aesthetics come together.

Comfort è una serie progettata da Matteo Thun per rendere l'ambiente bagno raffinato e piacevole, non solo per le persone con mobilità ridotta, ma anche per tutti gli utenti. Funzionalità, tecnologia ed estetica si fondono per servire coloro che hanno bisogno di aiuto e per i quali la sicurezza ha un valore prioritario anche in bagno. La serie è disponibile in due finiture: cromo e cromato/nero soft touch.

Comfort is a serie designed by Matteo Thun in order to make the bathrooms environment pleasing and refined, not only for people with reduced mobility, but (also) for all users. Functionality, technology and aesthetics come together to serve those who need help and for whom safety is a priority in the bathroom. The collection is available in two finishes: chrome and chrome plated/black soft touch.







CR
Cromato
Chrome-plated



CU
Cromato/nero soft touch
Chrome-plated/black soft touch



AH995

Maniglione di sicurezza
Safety grip
44 / 64 x 7H x 9 cm



1.500N
~150Kg

**AH995**

Maniglione di sicurezza
Safety grip
74 / 144 x 7H x 9 cm



1.500N
~150Kg

**AH992A**

Maniglione di sicurezza 135°
Safety grip 135°
55 x 27H x 9 cm



1.500N
~150Kg

**AH996**

Sostegno di sicurezza verticale.
Installazione da pavimento a parete
Vertical safety support.
Wall-to-floor installation
7 x 179H x 9 cm



1.500N
~150Kg

**AH993**

Sostegno di sicurezza ad L
L shaped safety support
36 x 67H x 9 cm



1.500N
~150Kg



AH993

Sostegno di sicurezza ad L
L shaped safety support
67 x 67H x 9 cm



1.500N
~150Kg

AH994

Sostegno di sicurezza ad angolo
Corner safety support
76 x 7H x 76 cm



1.500N
~150Kg

**AH9S5A**

Specchio basculante orientabile
Tilting adjustable mirror
80 x 60H x 12 cm

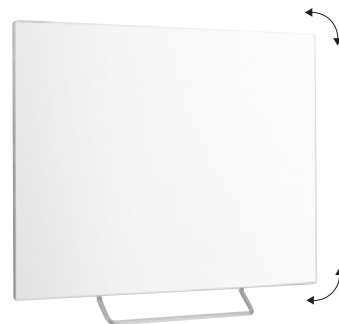
**AH9K1A**

Supporto a muro con placca design per
art. AH997A - AH997C
Wall support with design plate for arts.
AH997A - AH997C
8 x 12H x 1 cm



AH994

Sostegno di sicurezza ad angolo
Corner safety support
100 x 7H x 66 cm



1.500N
~150Kg

AH997A

Sostegno di sicurezza fisso zona lavabo/wc
Fixed safety support. Washbasin/wc zone
10 x 31H x 60 cm



1.500N
~150Kg

AH997C

Sostegno di sicurezza ribaltabile zona wc
Tip-up safety support. Wc zone
10 x 31H x 70 cm



1.500N
~150Kg

AH925X

Portarotolo per artt. AH997A - AH997C
Paper holder for arts. AH997A - AH997C
5 x 15H x 16 cm



GRAB-BARS

Una serie di maniglioni completa e dalle diverse finiture, realizzata secondo alti standard qualitativi per permettere di muoversi nell'ambiente bagno in totale sicurezza e facilità.

A serie of complete handles with different finishes, produced according to high quality standards to allow you to move in the bathroom safely and easily.





A0490

Maniglione di sicurezza
Safety grip
52 / 67 x 7H x 7 cm

**A0490T**

Maniglione di sicurezza
Safety grip
32 x 7H x 7 cm

**A0491T**

Maniglione di sicurezza
Safety grip
43 x 22H x 12 cm

**A10950**

Maniglione di sicurezza
Safety grip
36 x 5H x 6 cm

**A1095**

Maniglione di sicurezza
Safety grip
51 / 66 x 5H x 6 cm

**A13950**

Maniglione di sicurezza
Safety grip
35 x 3H x 7 cm

**A1390**

Maniglione di sicurezza
Safety grip
50 / 65 x 3H x 7 cm

**A30950**

Maniglione di sicurezza
Safety grip
32 x 7H x 7 cm

**A33950**

Maniglione di sicurezza
Safety grip
30 x 3H x 5 cm



A3395
Maniglione di sicurezza
Safety grip
45 / 60 x 3H x 5 cm

**A36950**

Maniglione di sicurezza
Safety grip
32 x 7H x 7 cm

**A4690M**

Maniglione di sicurezza
Safety grip
31 x 5H x 6 cm

**A30920**

Maniglione con cestino
Grab-bar with basket
43 x 22H x 12 cm

**A36920**

Maniglione con cestino
Grab-bar with basket
43 x 22H x 12 cm

**A0492T**

Maniglione con cestino
Grab-bar with basket
43 x 22H x 12 cm



A32920

Maniglione con cestino
Grab-bar with basket
42 x 21H x 12 cm



REV

A04620

Maniglione per doccia, con gomma
termoplastica antiscivolo e cestino
Grab-bar for shower, with anti-slip
thermoplastic rubber and basket
34 x 7H x 15 cm

**A0462A**

Maniglione per doccia, con gomma
termoplastica antiscivolo e cestino
Grab-bar for shower, with anti-slip
thermoplastic rubber and basket
34 x 7H x 15 cm

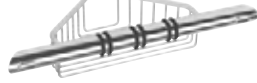
**A04610**

Appoggiapiedi per doccia con gomma
termoplastica antiscivolo
Foot rest bar for shower with anti-slip
thermoplastic rubber
34 x 3H x 3 cm

**A0461A**

Appoggiapiedi per doccia con gomma
termoplastica antiscivolo
Foot rest bar for shower with anti-slip
thermoplastic rubber
34 x 3H x 3 cm



STOOLS

Gli sgabelli doccia sono i complementi d'arredo utili e funzionali perfetti per rendere l'ambiente bagno più comodo e sicuro.

Shower stools are the useful and functional furnishing accessories perfect for making the bathroom environment more comfortable and safer.



A03750

Sgabello con seduta in resina ureica (UF)
e gambe in acciaio
Stool with seat in ureic resin (UF), steel
legs
38 x 41H x 38 cm

**A0436A**

Sedile ribaltabile per doccia
Folding shower seat
35 x 5H x 35 cm



1.600N
~160Kg

**A0438A**

Sedile estensibile per vasca
Extensible bathtub seat
65 x 18H x 35 cm



1.300N
~130Kg

**AV036B**

Sedile ribaltabile per doccia.
Antibatterico
Folding shower seat. Antibacterial
35 x 18H x 38 cm



1.600N
~160Kg

**AV375B**

Sgabello con seduta in ABS e struttura
in ottone cromato. Antibatterico
Stool with seat in ABS and structure
in brass structure. Antibacterial
35 x 46H x 33 cm



BASKET

Design e funzionalità si fondono per questa rinnovata serie di cestini per doccia: angolari, removibili, con vaschetta interna o appendibili alla parete doccia, offrono una scelta ampia e variegata

Design and functionality come together for this renewed serie of shower baskets: angular, removable, with internal tray or suspended from the shower wall, they offer a wide and varied choice.

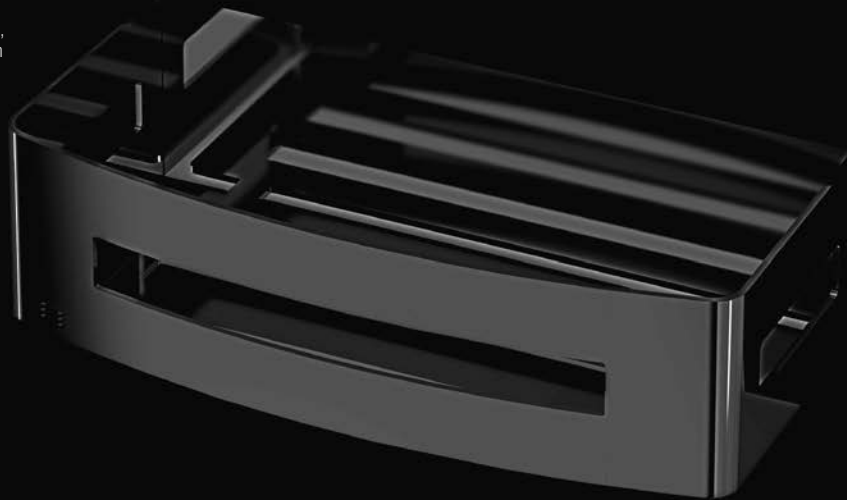



AV251C

Cestino
Basket
23 x 9H x 11 cm



click

**AV251A**

Cestino con bacinella antibatterica estraibile. Bacinella antiscivolo e anti-UV
Basket with removable antibacterial basin. Anti-slip and anti-UV basin
22 x 7H x 11 cm

**AV151F**

Cestino sganciabile
Removable basket
22 x 6H x 12 cm

**AV151E**

Cestino sganciabile
Removable basket
26 x 7H x 12 cm

**AV151D**

Cestino sganciabile
Removable basket
26 x 3H x 12 cm

**A55510**

Cestino
Basket
25 x 3H x 15 cm



click

**A1849A**

Cestino
Basket
15 x 3H x 10 cm

**A1851A**

Cestino
Basket
25 x 3H x 12 cm

**A18510**

Cestino
Basket
20 x 7H x 12 cm

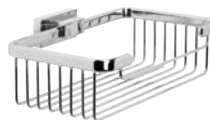
**A46510**

Cestino
Basket
35 x 6H x 13 cm

**A32500**

Cestino
Basket
21 x 6H x 14 cm

**A1351A**

Cestino
Basket
27 x 4H x 11 cm

**A1051B**

Cestino
Basket
29 x 3H x 13 cm

**A0451H**

Cestino
Basket
20 x 6H x 13 cm

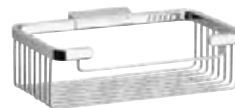
**A04500**

Cestino
Basket
13 x 3H x 9 cm



A04510

Cestino
Basket
20 x 3H x 12 cm

**A0453H**

Cestino
Basket
39 x 6H x 13 cm

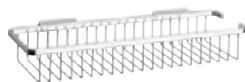
**AV0330**

Cestino doppio appendibile
Double basket, for hanging
26 x 75H x 25 cm

**AV231C**

Angolare
Corner
18 x 8H x 18 cm

**AV231A**

Angolare con bacinella antibatterica
estraibile. Bacinella antiscivolo e
anti-UV
Angular with removable antibacterial
cup. Anti-slip and anti-UV cup
18 x 7H x 18 cm

**AV131F**

Angolare sganciabile
Removable corner
17 x 6H x 17 cm

**AV131E**

Angolare sganciabile
Removable corner
19 x 7H x 19 cm

**AV131D**

Angolare sganciabile
Removable corner
19 x 3H x 19 cm

**A18310**

Angolare
Corner
16 x 7H x 17 cm

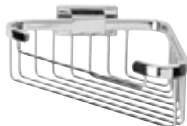
**A1331A**

Angolare
Corner
18 x 4H x 18 cm

**A1031B**

Angolare
Corner
21 x 2H x 21 cm

**AV031A**

Angolare
Corner
22 x 9H x 22 cm

**A0449H**

Angolare
Corner
16 x 6H x 16 cm



A04490

Angolare
Corner
16 x 3H x 16 cm



A05410

Cestino per vasca
Basket for bathtub
66 - 72 x 6H x 12 cm

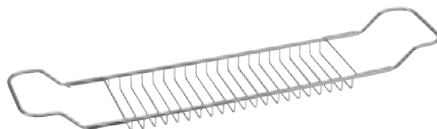

AV0320

Angolare doppio
Double corner
20 x 38H x 21 cm



AV032A

Angolare doppio
Double corner
22 x 39H x 21 cm



A04320

Angolare con 2 ripiani in PMMA
Double corner shelf in PMMA
17 x 32H x 17 cm



AV033A

Angolare doppio appendibile a destra
Double corner, right mounting
20 x 75H x 32 cm



AV033B

Angolare doppio appendibile a sinistra
Double corner, left mounting
20 x 75H x 32 cm





STANDS

Nel valore della semplicità, le piantane nascono da una interpretazione del classico fra eleganza nelle forme e essenzialità nei materiali. Accessori dove funzionalità ed estetica si fondono in un raro equilibrio esaltato dalla cura per il dettaglio.

In the simplicity value, the stands born from an interpretation of classic between elegance in the forms and the essentiality of materials. Accessories where functionality and aesthetics are blended together in a rare equilibrium, enhanced by the care for details.

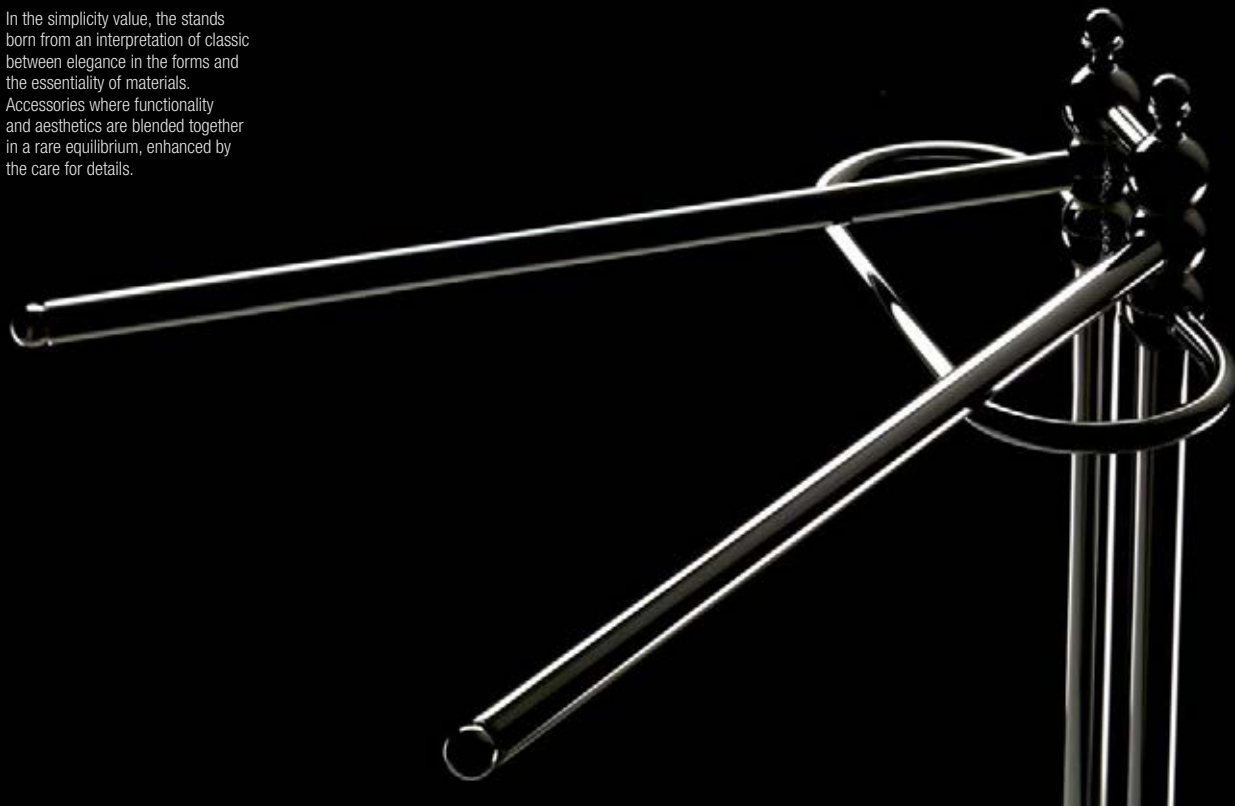



A05880

Piantana con 4 portasalviette e 4
appendiabiti
Stand with 4 towel holders and 4 clothes
hangers
25 x 180H x 57 cm

**A33850**

Piantana con 2 portasalviette
Stand with 2 towel holders
24 x 88H x 40 cm

**A05840**

Piantana con 3 portasalviette
Stand with 3 towel holders
27 x 89H x 55 cm

**AV085C**

Piantana con 2 portasalviette
Stand with 2 towel holders
46 x 90H x 25 cm

**A05850**

Piantana con 4 portasalviette
Stand with 4 towel holders
27 x 96H x 55 cm



AV085D

Piantana con 3 portasalviette
Stand with 3 towel holders
26 x 89H x 48 cm

**AV085F**

Piantana con 3 portasalviette
Stand with 3 towel holders
19 x 88H x 39 cm

**AV086D**

Piantana con portarotolo e portascopino
Stand with paper and toilet brush holder
26 x 73H x 26 cm

**AV086E**

Piantana con portarotolo e portascopino
Stand with paper and toilet brush holder
19 x 72H x 30 cm



TABLETOP SERIES

Accessori dal design contemporaneo, essenziale e dalle forme semplici e facili da pulire, curati nei dettagli e abbinabili perfettamente a tutte le Serie Inda.

Accessories with a contemporary design, essential and simple shapes that are easy to clean, with attention to detail and perfectly suited to all Inda series.





A2010Z

Portabicchiere da appoggio con
bicchiere in vetro
Tabletop tumbler holder with glass
tumbler
9 x 11H x 9 cm

**A2011Z**

Portasapone da appoggio con
bacinella in vetro
Tabletop soap holder with glass dish
11 x 4H x 11 cm

**A2012Z**

Spandisapone da appoggio, con
contenitore in vetro ed erogatore in finitura
Tabletop soap dispenser with glass
container and pump in finishing
9 x 16H x 9 cm



0,25 Lt.

A1810Z

Portabicchiere da appoggio con
bicchiere in vetro satinato
Tabletop tumbler holder with
satined glass tumbler
7 x 10H x 7 cm

**A1811Z**

Portasapone da appoggio con
bacinella in vetro satinato
Tabletop soap holder with
satined glass dish
12 x 4H x 12 cm

**A1812Z**

Spandisapone da appoggio, con
contenitore in vetro satinato ed erogatore
in finitura
Tabletop soap dispenser with satined glass
container and pump in finishing
7 x 15H x 8 cm



0,25 Lt.

A20010

Portabicchiere da appoggio con
bicchiere in vetro satinato
Tabletop tumbler holder with
satined glass tumbler
8 x 10H x 8 cm

**A20020**

Portasapone da appoggio con
bicchiere in vetro satinato
Tabletop soap holder with satinod
glass tumbler
13 x 5H x 13 cm

**A20060**

Spandisapone da appoggio, con
contenitore in vetro satinato ed erogatore
in finitura
Tabletop soap dispenser with satinod
glass container and pump in finishing
8 x 16H x 9 cm



0,25 Lt.

A5710Z

Portabicchiere da appoggio con
bicchiere in vetro satinato
Tabletop tumbler holder with satinated
glass tumbler
25 x 12H x 11 cm

**A5711Z**

Portasapone da appoggio con
bacinella in vetro satinato
Tabletop soap holder with satinated
glass dish
25 x 5H x 11 cm

**A5712Z**

Spandisapone da appoggio con
contenitore in vetro satinato, erogatore in
ottone cromato
Tabletop soap dispenser with satinated glass
container and chrome-plated brass pump
25 x 18H x 11 cm



0,25 Lt.

**AV0710**

Portakleenex da appoggio in ABS
Tabletop kleenex dispenser in ABS
26 x 6H x 14 cm

**A4610Z**

Portabicchiere da appoggio con
bicchiere in vetro satinato
Tabletop tumbler, with satinated glass
tumbler
8 x 14H x 8 cm

**A4611Z**

Portasapone da appoggio con
bacinella in vetro satinato
Tabletop soap holder with satinated
glass dish
13 x 7H x 13 cm

**A4667Z**

Spandisapone da appoggio con
contenitore in vetro satinato, erogatore in
ottone cromato
Tabletop soap dispenser with satinated glass
container and chrome-plated brass pump
8 x 19H x 9 cm



0,25 Lt.

**AV071Z**

Portakleenex da appoggio in ABS
Tabletop kleenex dispenser in ABS
14 x 13H x 14 cm

**A5510Z**

Anello supporto da appoggio
Support ring
9 x 2H x 9 cm

**R1510B**

Bicchiere
Tumbler
8 x 11H x 8 cm

**R1511B**

Bacinella
Dish
11 x 4H x 11 cm

**R1512B**

Spandisapone
Soap dispenser
8 x 16H x 9 cm



0,25 Lt.



MIRRORS AND LAMPS

A completare l'offerta di Accessori Inda, troviamo un'ampia gamma di Specchi d'arredo e Lampade, adatti a tutti gli ambiente e sempre perfettamente abbinabili con gli Accessori del marchio.

To complete the Inda accessory offer, we find a wide range of Mirrors and Lamps, suitable for all environments and always perfectly matched with the brand's Accessories.

















FINISHES

La creatività trova libera espressione in un sistema sartoriale dei nostri spazi, dei nostri gusti e della nostra identità. Ampia gamma di finiture per la personalizzazione di un ambiente esclusivo.

Creativity finds its expression in a system always tailored to one's spaces, tastes and identity. Wide range of finishes for customizing an exclusive environment.



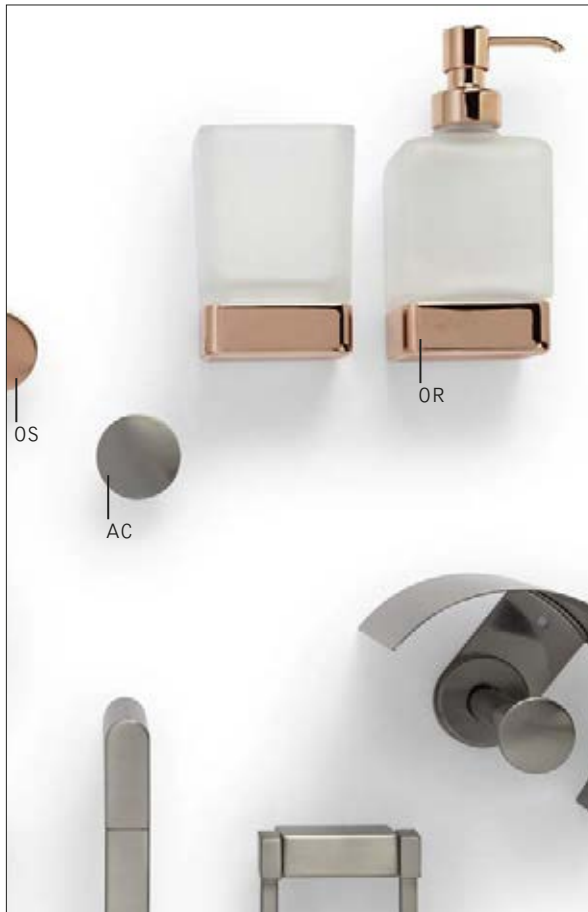
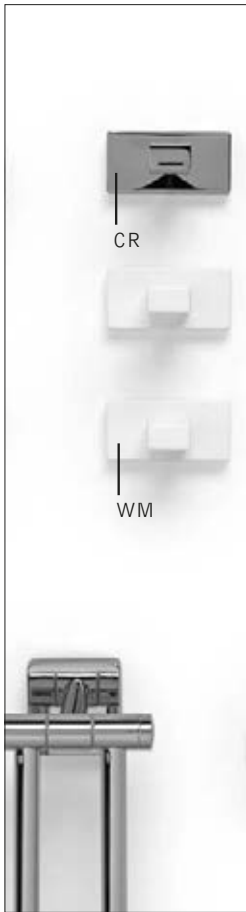



CR
Cromato
Chrome-plated



CF
Cromo nero lucido
Glossy black chrome



OR
Oro rosato lucido
Glossy rose-coloured gilded



DR
Dorato 24 carati
Gilded 24 carats



WM
Bianco opaco
Matt white



AS
Acciaio inox satinato AISI 304
Satin stainless steel AISI 304



NS
Acciaio inox spazzolato AISI 304
Brushed stainless steel AISI 304



AC
Nickel spazzolato
Brushed nickel



CG
Cromo nero spazzolato
Brushed black chrome



OS
Oro rosato spazzolato
Brushed rose-coloured gilded

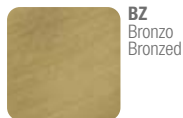

BZ
Bronzo
Bronzed



NE
Nero opaco
Matt black



AL
Acciaio Inox AISI 304
Stainless steel AISI 304



AP
Alluminio lucido
Polished aluminium



DL
Cromato/smoke
Chrome-plated/smoke

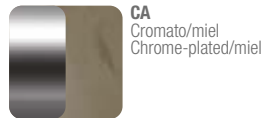

CA
Cromato/miel
Chrome-plated/miel



SL
Silver
Silver



CD
Cromato/dorato
Chrome-plated/gilded

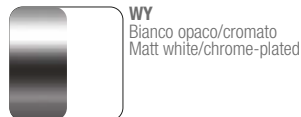

WY
Bianco opaco/cromato
Matt white/chrome-plated



WC
Bianco/cromo
White/chrome



WZ / WW
Bianco lucido RAL 9016
Glossy white RAL 9016



NC
Nero opaco/cromato
Matt black/chrome-plated



SN
Silver/nero
Silver/black



CU
Nero opaco/cromato
Matt black/chrome-plated



NC
Cromato/nero soft touch
Chrome-plated/black soft touch

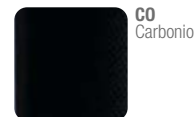

CO
Carbonio

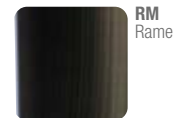

RM
Rame



CS
Classic



ML
Militare



GE
Geometric

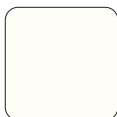

BX
Laccato opaco Bianco
Mat lacquered Bianco



CE
Laccato opaco Cemento
Mat lacquered Cemento



NX
Laccato opaco Nero
Mat lacquered Nero



TL
Laccato opaco Terra di Luna
Mat lacquered Terra di Luna



AQ
Laccato opaco Aquamarina
Mat lacquered Aquamarina

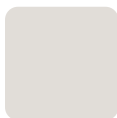

MP
Laccato opaco Perla
Mat lacquered Perla



CX
Laccato opaco Creta
Mat lacquered Creta



AX
Laccato opaco Avorio
Mat lacquered Avorio



BN
Laccato opaco Bruno
Mat lacquered Bruno



GD
Laccato opaco Giada
Mat lacquered Giada



Textil ice



Larice panna

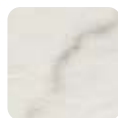

Calacatta



Malta



Textil grey



Larice sand



Porfido



Pietra chiara



Textil brown



Larice brown



Pietra scura



Cemento scuro



Fiore bianco

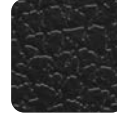

Fiore nero



Yard



Lava



01
Vetro trasparente
Transparent glass



03
Vetro extrachiaro trasparente
Extra clear transparent glass



02
Polimetilmetacrilato
Polymethyl methacrylate



21 / 26
Vetro satinato
Satined glass



001
Vetro trasparente + Cromato
Transparent glass + Chrome-plated



005
Vetro trasparente + Nero opaco
Transparent glass + Matt black



007
Vetro trasparente + Nickel spazzolato
Transparent glass + Brushed nickel



002
Vetro satinato + Cromato
Satined glass + Chrome-plated



006
Vetro satinato + Nero opaco
Satined glass + Matt black



008
Vetro satinato + Nickel spazzolato
Satined glass + Brushed nickel



07
Ceramica bianca
White ceramic



Marchio TÜV - Certifica la resistenza meccanica sotto i carichi indicati.
TUV mark - It certifies the mechanical resistance to the indicated loads.



Antibatterico
Antibacterial



Illuminazione a led
Led lighting



Bacinella con foro
Dish with hole



Fissaggio con tasselli
Fixing with plugs



Sistema autocentrante
Self-centering-system



Regolazione del colore della luce
Light color adjustment

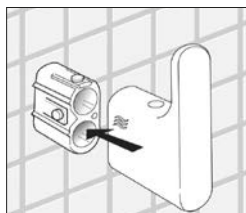

Ricaricabile
Rechargeable



Regolazione dell'intensità della luce
Light intensity adjustment



Capacità di contenimento
Containment capacity



Temperatura del colore della luce
(tonalità)
Color temperature

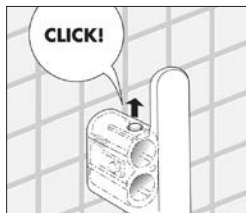

Resistenza meccanica
Mechanical resistance



Grado di protezione IP
IP protection level



Installazione reversibile
Reversible installation



Fattore di ingrandimento
Magnifying factor



Possibile installazione a muro
mediante adesivo in pasta
Possible wall-mounted installation
with paste adhesive



Installazione non reversibile
Not reversible installation



Presca elettrica
Electrical plug



Kit fissaggio a parete
Fixing kit with glue



Articoli sganciabili
Removable products



Base antiscivolo
Anti-slip base

Inda si riserva, a proprio insindacabile giudizio, di apportare modifiche anche senza preavviso, allo scopo di migliorare la produzione.

Inda reserves the right to modify the products without advance notice to improve production.

INDA SpA

Registered Office
Operational Headquarters
Via dell'Industria, 41
I-24040 Pagazzano (BG)

Bathroom Furniture
Via Postumia Ovest, 72
I-31048 Olmi di San Biagio di Callalta (TV)

www.inda.net
info@inda.net

PIva: IT03868760962
Registro Imprese di Bergamo: 03868760962
Numero REA: BG – 386581
Capitale Sociale: Euro 4.000.000,00 i.v.



